

Technical specifications

Rain collector/Tipping spoon

RAIN-O-MATIC PROFESSIONAL measures the precipitation by means of a funnel (orifice 200 cm²), which leads the water down into the self-emptying tipping POM bucket, held in place by a hard ferrite magnet. The magnet always exerts just enough tension to allow the measuring bucket to empty in one quick movement (less than 300 ms) and then return to its normal position, ready to once again collect precipitation. This means the counter weight always remains the same opposite to other conventional two spoons tipping bucket rain gauges.

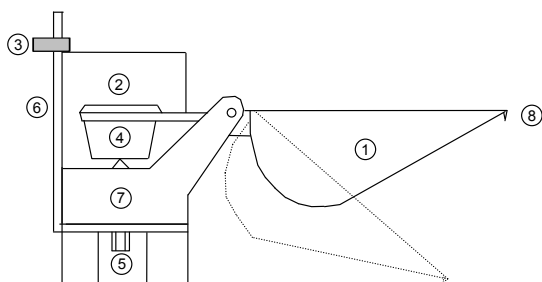

1. Self-emptying bucket
2. PCB with reed switch
3. Screw to hold the entire unit
4. Magnet
5. Adjustment screw
6. Angle brackets
7. Holder for bucket
8. Drip catcher

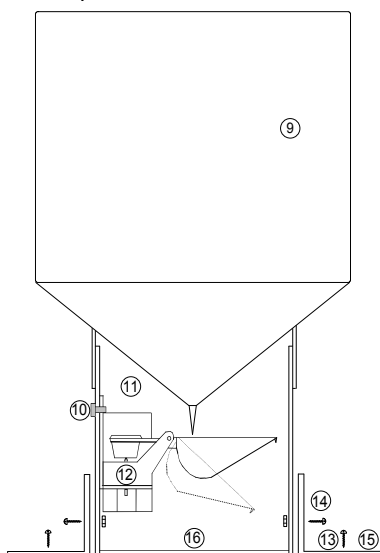

9. Funnel with grille
10. Screw for whole measurement unit
11. Box with measurement unit
12. Measurement unit
13. 4 pcs. screw
14. 4 pcs. screw with nuts
15. 2 pcs. angle brackets
16. Baseplate

Styrosun

The rain gauge is mainly made in moulded modified high-impact polystyrene also known as STYROSUN which is a highly weather-resistant polymer that reduces breakdown and discoloration.

STYROSUN which has passed the Arizona test is extremely resistant against the sun's UV radiation and it is frost- and heat resistant standing all climatically conditions.

STYROSUN is resistant to common household cleaners, recyclable and easily decorated.

PCB

The electronic printed circuit board with individually tested and high quality reed switches is protected against extreme weather conditions such as extreme frost or heat. This include corrosion from salt water due to the PCB is coated with weather-resistant varnish.

The printed circuit board comes in two versions

- Version 1: PCB No. 9601 (NC—normally closed) has male connection and 1 reed switch .

PCB no. 9601 PCB no. 9602

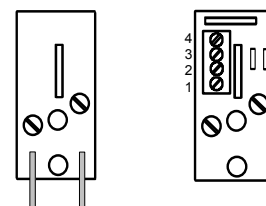

- Version 2: PCB No. 9602 (NC—Normally closed, NO—Normally open) Terminal strip, 4 connections / 2 outlets) and 2 reed switches, connected-up in series by 1 k W 1/4W resistor.

Typical switching times for PCB 9602

Resolution	Terminal 1-2 Normally closed	Terminal 3-4 Normally open
0,10 mm	443ms $\sigma = 14\text{mS}$	352ms $\sigma = 14\text{mS}$
0,20 mm	307ms $\sigma = 12\text{mS}$	278ms $\sigma = 12\text{mS}$
0,25 mm	326ms $\sigma = 11\text{mS}$	301ms $\sigma = 12\text{mS}$
0,50 mm	322ms $\sigma = 7\text{mS}$	305ms $\sigma = 8\text{mS}$

σ = Standard deviation

Filter design: Max 200msec recommended.

Resolution

- 0,10 mm
- 0,20 mm
- 0,25 mm
- 0,50 mm

Patent

RAIN-O-MATIC PROFESSIONAL is patented and protected by the Law of Copyright. Patent no. UM-27598, AU pat. 565951, EPO Pat. 014212, US pat. 4.644.786, CA Pat. 126181, Japan Pat. 501208/83 Taiwan Reg. 74-201292 Components may NOT be used for other products or purposes without a written

Measurements

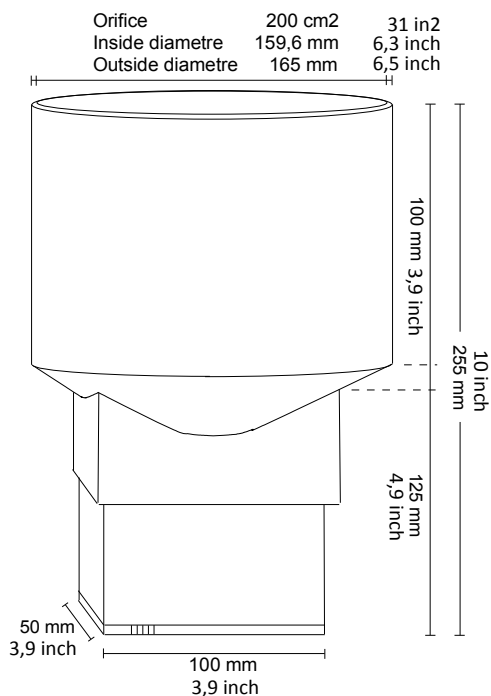

Splash room height
 incl. bottom: 170 mm 6,7 inch
 Weight incl. angle brackets: 380 g 13,5 oz

Capacity per minute with 12 tips

0,10 mm: 1,2 mm
 0,20 mm: 2,4 mm
 0,25 mm: 3,0 mm
 0,50 mm: 6,0 mm

Item list of complete collectors

Rain collector with PCB no. 9601 resolution 0,10 mm	300.021-10
Rain collector with PCB no. 9601 resolution 0,20 mm	300.021-20
Rain collector with PCB no. 9601 resolution 0,25 mm	300.021-25
Rain collector with PCB no. 9601 resolution 0,50 mm	300.021-50
Rain collector with PCB no. 9602 resolution 0,10 mm	300.023-10
Rain collector with PCB no. 9602 resolution 0,20 mm	300.023-20
Rain collector with PCB no. 9602 resolution 0,25 mm	300.023-25
Rain collector with PCB no. 9602 resolution 0,50 mm	300.023-50

Rainfall intensity diagrams

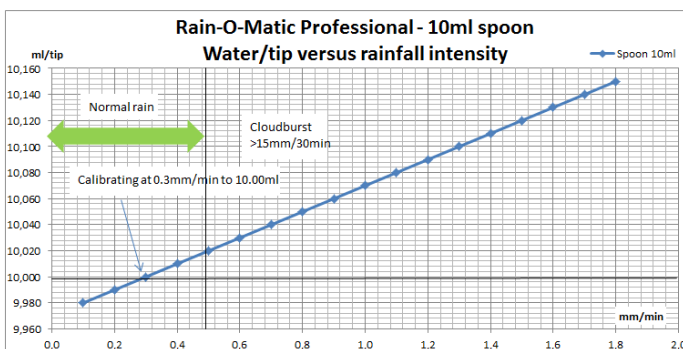
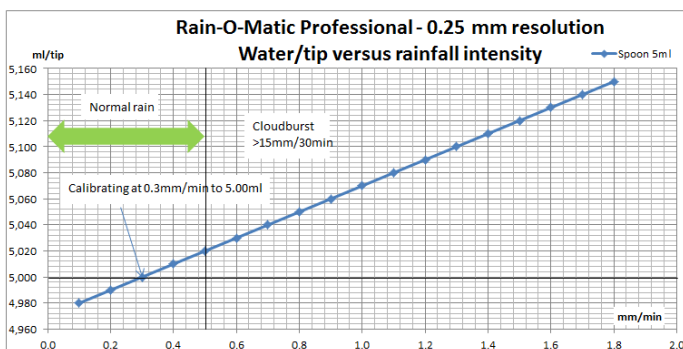
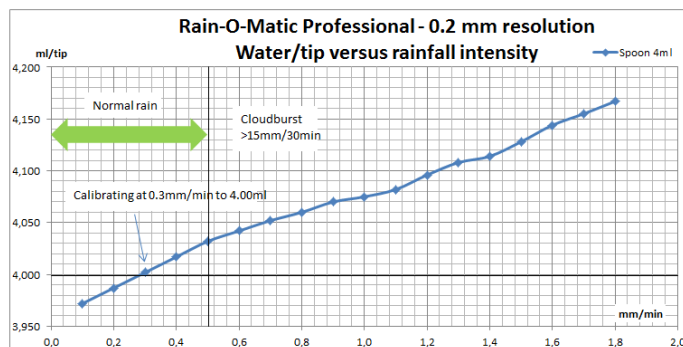
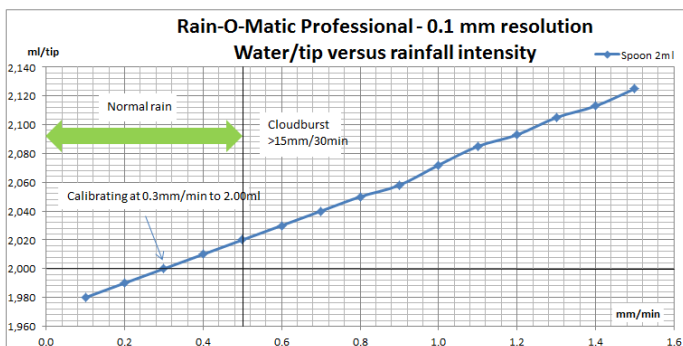

Repeatability diagrams

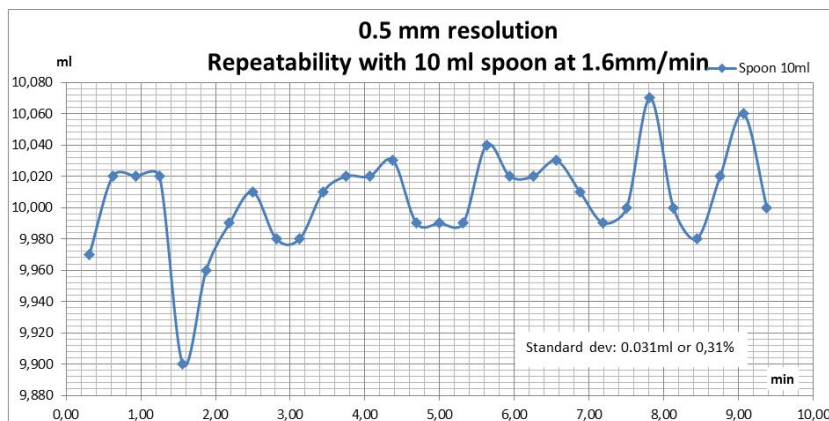
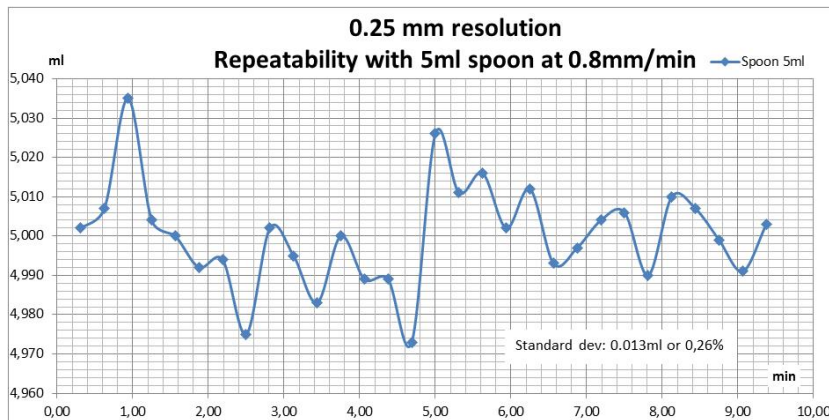
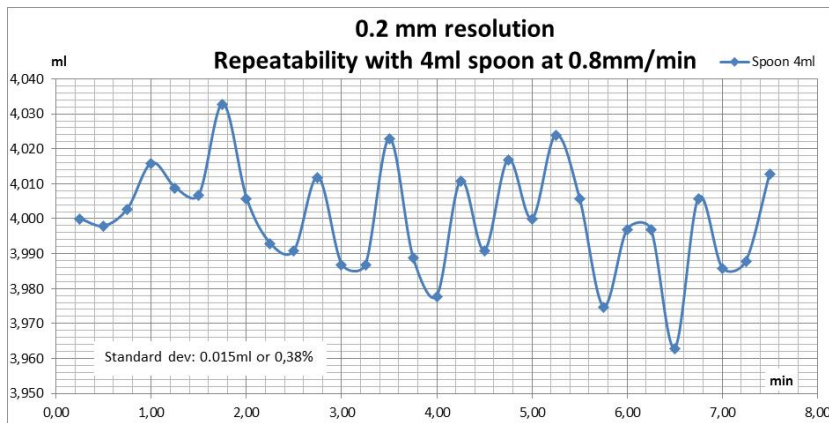
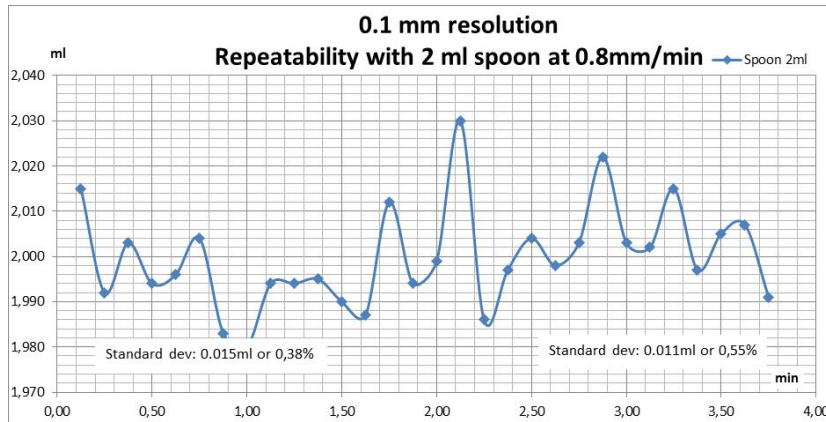

Rain-O-Matic Professional rain gauge with our patented self-emptying tipping bucket is one of the most accurate and reliable precipitation gauges on the market and for 28 years we have supplied more than 200.000 rain gauges to 41 countries on 5 continents.



We deliver our products to OEM customers only and we are not competing with you for the end user.

Tipping bucket

RAIN-O-MATIC Professional patented self-emptying tipping bucket is one of the most accurate and reliable rain gauges on the market. It gives you advantages in:

- More accurate measurements.
- Only one adjustment screw which makes it easy to recalibrate.
- Bucket made in POM, which is a more dismissive material and therefore makes dust and dirt not stick so easily on the spoon and maximize water release.

Calibration

Calibration is a very important issue for Pronamic and therefore all Professional rain gauges are manually calibrated. It gives you the guarantee for a very accurate measurement. Accuracy: +/- 2%.

Minimal maintenance

Our rain gauges require minimal maintenance due to:

- Outer shell is made from Styrosun which makes the surface easy to clean.

- High quality materials and a simple design for a very long durability (10-20 years)

Full customization

Our strength is customized solutions for the individual customer. Rain-O-Matic Professional Rain Gauge can for example be customized especially to your demands regarding:

Mounting brackets

Don't worry about if the rain gauge fit your system.

Color Match

Get the rain gauge in your company/product color(s)

Logo Match

Branding of your own brand/company name. If you have other demands, please let us know.

Flexible cable connections

We can manufacture the rain gauges with a variety of connection cables so they will fit into your system. For example:

- Binder connection.
- Jack plug.
- Standard two poles.

Applications areas

The Rain-O-Matic Professional Rain Gauge is light (380 gr) but rugged which makes it perfect for:

- Weather stations (MAWS)
- Water works
- Wastewater treatment plants
- Hydropower stations
- Irrigation
- Agriculture
- Military
- Highway Authorities
- Constructions Engineers
- Forestry

Prices and logistics

We deliver directly to you. We have no agents, distributors or other expensive middlemen.

Prices:

Let us have your estimate for quantities and we will come back to you within 2 days on weekdays.

Our strength is customizing, so please don't hesitate to contact us for a price request on some specific demands.

Freight

Due to its size and lightness it is quite economic to freight worldwide. Free shipping for order over 50 pieces. Less than 50 pieces, please contact us for an offer.

Time of delivery

From week to week depending on the size of the order.

Tests

Rain-O-Matic Professional Rain Gauge has been thoroughly tested by the Danish Ministry of Agriculture, State Field Experiment, Department of Agricultural Meteorology, Research Center Foulum, DK-8830 Tjele

All components are RoHS compliant. Rain-O-Matic Professional has been tested 100 % frost proof.

Warranty

Our rain gauges are of such a high quality that we offer 24 months of warranty on mechanical- and plastic parts. See Service & Support for further information.

Accessories

Currently we can offer following accessories:

- Air Bubble leveling
- Standard 1m binder cable
- Bird protection
- Leaf filter
- Standard pole bracket
- Spider protection